

Please, read this manual  
carefully before use!

Owner's Manual



## Inverter Generator

KS 4100iE  
KS 4100iEG  
KS 8100iE  
KS 8100iEG  
KS 8100iE ATSR  
KS 8100iEG ATSR

## Inverter Generator in Soundproof Housing

KS 2000i S  
KS 2000iG S  
KS 4000i S  
KS 4000iEG S

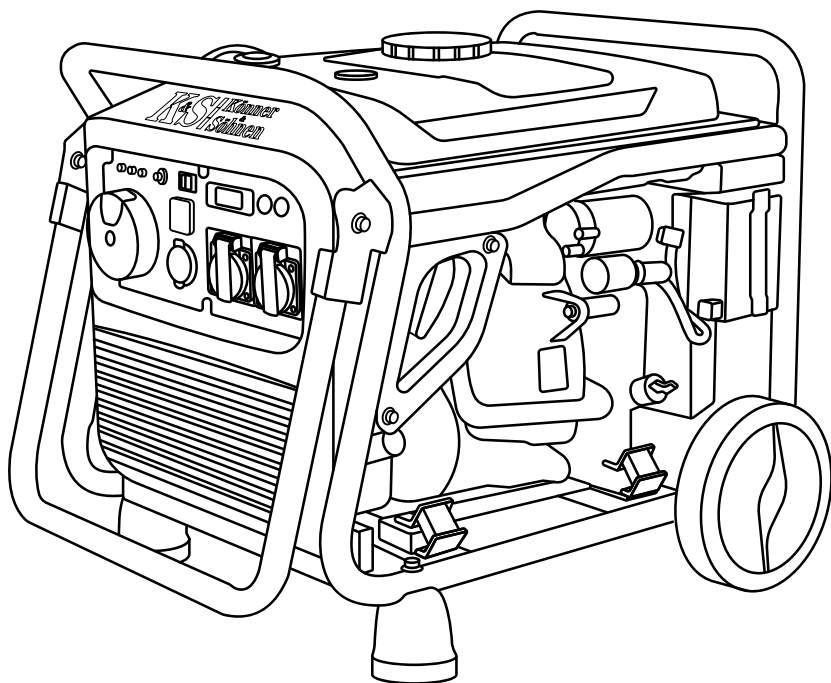



Thank you for your purchase of **Könner & Söhnen** products. This manual contains a brief description of safety, use and debugging. More information can be found on the official manufacturer's website in the support section: [ks-power.de/betriebsanleitungen](https://www.ks-power.de/betriebsanleitungen).

You can also go to the support section and download the full version of the manual by scanning the QR code, or on the website of the official importer of Könner & Söhnen products: [www.ks-power.de/en](https://www.ks-power.de/en)



*We care about the environment, therefore, we consider it expedient to save paper and leave in print a short description of the most important sections.*



**Be sure to read the full version of the manual before getting started!**



Manufacturer reserves the right to make alterations into the generators, which may not be reflected in this manual. Pictures and photos of the product may vary from its actual appearance. At the end of this manual, You may find contact information which you are free to use in case of any issues occurrence.

All data, specified in this operation manual is the most up to date for the moment of its publishing. The current list of service centers you can find at the website of official importer: [www.ks-power.de/en](https://www.ks-power.de/en)



**ATTENTION – DANGER!**



**Failure to follow the recommendations marked with this sign may lead to serious injury or death of the operator or third parties.**



**IMPORTANT!**



**Useful information while operating the machine.**

## SAFETY INFORMATION

# 1

Do not use the generator in rooms with poor ventilation or in conditions of excessive humidity. Do not place the generator in water or on moist soil. Do not expose the generator to rain, snow, as well as to direct sunlight for a long time. Place the generator on a flat, hard surface, away from flammable liquids/gases (at a minimum distance of 1 m). Keep unauthorized persons, children, and animals away from work area. Wear safety shoes and gloves.



**ATTENTION – DANGER!**



**During operation of the engine, the generator allocates exhaust gases CO<sub>2</sub>, that can cause poisoning. Do not use the device in closed, badly ventilated areas.**

## ELECTRICAL SAFETY

# 1.1



**ATTENTION – DANGER!**



**The device generates electricity. Follow safety precautions to avoid electric shock.**

The generator produces electricity that may lead to an electric shock while neglecting compliance regulations. Könner & Söhnen generators were initially designed as an IT system with basic protection by insulation of hazardous live parts according to DIN VDE 0100-410. The generator housing is insulated from the current-carrying L and N conductors. The generator must be grounded in all cases, except for an IT system with an insulated neutral wire and bonding. A grounded IT system requires the use of an insulation monitoring device. Further details regarding the use of the generator in IT and TN systems can be found on our website or requested from our technical support. Wires with damaged or spoiled insulation should be replaced. You should also replace worn, damaged or rusty contacts.



**IMPORTANT!**



**Using device for other purposes deprives the right for free warranty.**



ATTENTION – DANGER!

Be careful. Do not operate the generator, if you are tired, under the influence of drugs or alcohol. Inattention may cause a serious injury.

## PRECAUTIONS WHEN WORKING WITH GASOLINE GENERATOR

1.2

Do not start the generator operation upon presence of electric load! Disconnect the load before you stop the engine. **Only unleaded gasoline is recommended for the generator.** It is forbidden to use kerosene or other fuel types. Before running the generator, it is necessary to define the place and means of its emergency stop. Do not refuel the running generator.



ATTENTION – DANGER!

Fuel contaminates the land and groundwater. Do not allow the leaking gasoline from the tank!

## PRECAUTIONS WHEN WORKING WITH HYBRID GENERATOR

1.3



IMPORTANT!

For dual fuel models, only propane-butane mixture for cars (LPG) can be used as gas! It is forbidden to use any other gas!

Do not start the generator operation upon presence of electric load! Before usage make sure, that all the hoses are connected properly. In case of gas leakage, stop the gas flow from the source to generator and ventilate the room as soon as possible. For stopping gas powered engine: disconnect all the connected devices first, then close the gas valve, then turn off the engine. After that set the starter switch to OFF position and turn off the gas supply valve.

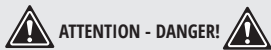

ATTENTION – DANGER!

Do not allow sparks near gas powered generator during its work



ATTENTION – DANGER!

The gas cylinder valve must not be closed when the generator is not running. The generator must not be operated on gas in basements.



ATTENTION – DANGER!

Pay attention! Usage of gasoline together with liquefied gas is forbidden! When you operate using gasoline, you must stop LPG supply. When you operate generator using LPG - you must stop gasoline supply.

## MAIN OVERVIEW

2

MODELS KS 4100iE, KS 8100iE, KS 4100iEG, KS 8100iEG ATSR, KS 8100iE ATSR, KS 8100iEG

1. Fuel tank cap
2. Fuel level indicator
3. Control panel
4. Carrying handles
5. Manual starter  
(only for models KS 4100iE, KS 4100iEG)
6. Transport wheels
7. Oil-depth gage

1. Multifunctional engine switch  
(except for dual-fuel models)
2. Oil level indicator
3. Overload indicator
4. Voltage indicator
5. Reset button

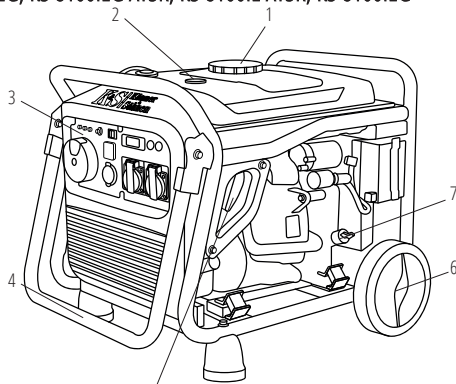

6. 12V DC fuse
7. Economy mode switch (ECON)
8. LED display
9. Generator parallel socket (except for KS 8100 model modifications)
10. Earthing bolt
11. 2x16A AC outlets (for KS 8100 model modifications, sockets 1\*16A, 1\*32A)
12. 12V/8.3A DC outlet (except for dual-fuel models)
13. 2 USB-Outputs
14. For LPG/gasoline models, the control panel has an air choke (except for KS 8100iEG ATSR, KS 8100iEG) and a fuel switch. Use the start button instead of the multifunction engine switch or engine start key.
15. Models KS 8100iEG ATSR and KS 8100iE ATSR use a control panel with an ATS (Automatic Transfer Switch) output.

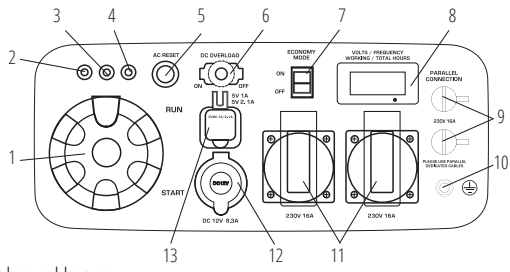

**IMPORTANT!** **Manufacturer reserves the right to make changes and/or improvements in design, components set and technical attributes without notice and without incurring obligation. The pictures in this manual are schematic and may not match the parameters of original product.**

### MODELS KS 2000i S, KS 2000iG S

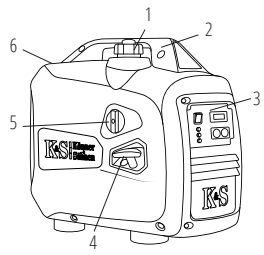

1. Fuel tank cap air vent
  2. Carrying handles
  3. Control panel
  4. Manual starter
  5. Air choke (для моделі KS 2000i S)  
Fuel switch for model KS 2000iG S
- Model KS 2000iG S has an air choke located on its control panel.
6. Maintenance cover (on the other side of the generator)

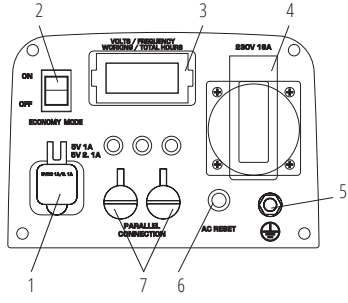

1. 2 USB-Outputs
2. Economy mode switch (ECON)
3. LED display
4. 1x16A AC outlet
5. Earthing bolt
6. Reset button
7. Generator parallel socket

### MODELS KS 4000iE S, KS 4100iEG

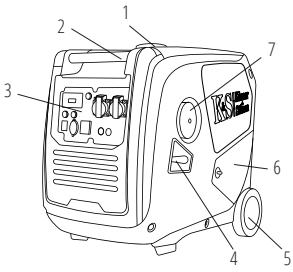

1. Fuel tank cap
2. Carrying handles
3. Control panel
4. Manual starter
5. Transport wheels
6. Maintenance cover
7. Multifunction engine switch (For KS 4100iE G - fuel type switch. Engine switch and air choke are located on the control panel)

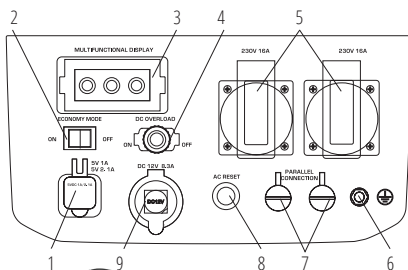

- 2 USB-Outputs
- Economy mode switch (ECON)
- LED display with oil level indicator, overload indicator, voltage indicator
- 12V DC fuse
- 2x16A AC outlets
- Earthing bolt
- Generator parallel socket
- Reset button
- 12V/8A DC outlet (except for KS 4100iEG model)



In addition to the components shown in the figure of a gasoline generator, a generator with a hybrid system (LPG/ gasoline) is equipped with a hose for supplying LPG to the generator.

- Built-in reducer.
- Gas cylinder connection hose (1.5 m).

SPECIFICATIONS

3

Model	KS 2000i S	KS 2000i G	KS 4000i S	KS 4000iEG S
Voltage, V	230			
Maximum power, kW	2.0	2.0*	4.0	4.0*
Nominal power, kW	1.8	1.8*	3.5	3.5*
Frequency, Hz	50			
Current, A (max.)	8.7	8.7	17.4	17.4
Outlets	1*16A	1*16A	2*16A	2*16A
Engine start	manual	manual	manual/electro	manual/electro
Fuel tank volume, l	4	4	12	12
Working time at 50% load (gasoline fuel)**, h	5.0	5.0	7.8	7.8
LED display	voltage, frequency, working hours		multifunctional***	
Noise level Lpa (7m)/Lwa, dB	62/87	62/87	66/91	66/91
Output 12V, A	-	-	12V/8,3A	-
USB-Outputs	5V/1A, 5V/2.1A	-	5V/1A, 5V/2.1A	5V/1A, 5V/2.1A
Engine model	KS 100i	KS 100i	KS 240i	KS 240i
Engine volume, cm <sup>3</sup>	79.7	79.7	223	223
Engine type	gasoline, 4 stroke cycle engine	LPG/gasoline 4 stroke cycle engine	gasoline, 4 stroke cycle engine	LPG/gasoline 4 stroke cycle engine
Engine power, hp	2.5	2.5	7.5	7.5
Generator parallel socket	+	+	+	+
Crankcase volume, l	0.35	0.35	0.6	0.6
Power factor, cos φ	1	1	1	1
Dimensions (L*W*H), mm	510*310*525	665*310*575	630*475*570	775*475*570
Lithium battery, Ah	-	-	1.6	1.6
Net weight, kg	15.6	15.6	40	40
Protection class	IP23M			
<b>Nominal voltage tolerance – max. 5%</b>				

\*LPG operation reduces generator power by 10%.

\*\*Fuel consumption depends on many factors, such as load, fuel quality, season, altitude, technical condition of the generator.

\*\*\*Multifunctional LED-display: load, fuel level, voltage, frequency, working hours; overload indicator, voltage indicator, oil level indicator.

Model	KS 4100iE	KS 4100iEG	KS 8100iE	KS 8100iEG	KS 8100iE ATSR	KS 8100iEG ATSR
<b>Voltage, V</b>	230					
<b>Maximum power, kW</b>	4.0	4.0*	8.0	8.0*	8.0*	8.0*
<b>Nominal power, kW</b>	3.6	3.6*	7.2	7.2*	7.2*	7.2*
<b>Frequency, Hz</b>	50					
<b>Current, A (max.)</b>	17.4	17.4	34.8	34.8	34.8	34.8
<b>Outlets</b>	2*16A	2*16A	1*16A, 1*32A	1*16A, 1*32A	1*16A, 1*32A	1*16A, 1*32A
<b>Engine start</b>	manual/ electro	manual/ electro	electro	electro	electro	electro
<b>Fuel tank volume, l</b>	12.5	12.5	20	20	20	20
<b>Working time at 50% load (gasoline fuel)**, h</b>	8.1	8.1	7.1	7.1	7.1	7.1
<b>LED display</b>	voltage, frequency, working hours					
<b>Noise level Lpa (7m)/Lwa, dB</b>	70/95	70/95	70/95	70/95	70/95	70/95
<b>Output 12V, A</b>	12V/8,3A	-	12V/8,3A	-	12V/8,3A	-
<b>USB-Outputs</b>	5V/1A 5V/2.1A	5V/1A 5V/2.1A	5V/1A 5V/2.1A	5V/1A 5V/2.1A	5V/1A 5V/2.1A	5V/1A 5V/2.1A
<b>Engine model</b>	KS 240i	KS 240i	KS 480i	KS 480i	KS 480i	KS 480i
<b>Engine volume, cm<sup>3</sup></b>	223	223	458	458	458	458
<b>Engine type</b>	gasoline, 4 stroke cycle engine	LPG/gasoline 4 stroke cycle engine	gasoline, 4 stroke cycle engine	LPG/gasoline 4 stroke cycle engine	gasoline, 4 stroke cycle engine	LPG/gasoline 4 stroke cycle engine
<b>Engine power, hp</b>	7.5	7.5	16	16	16	16
<b>Generator parallel socket</b>	+	+	-	-	-	-
<b>Crankcase volume, l</b>	0.6	0.6	1.1	1.1	1.1	1.1
<b>Power factor, cos φ</b>	1	1	1	1	1	1
<b>ATS input</b>	-	-	-	-	+	+
<b>Dimensions (L*W*H), mm</b>	605*420*425	685*420*430	725*505*555	765*505*555	725*505*555	765*505*555
<b>Lithium battery, Ah</b>	1.6	1.6	1.6	1.6	1.6	1.6
<b>Net weight, kg</b>	36.7	38	65.8	68	68	68
<b>Protection class</b>	IP23M					
<b>Nominal voltage tolerance – max. 5%</b>						

\*LPG operation reduces generator power by 10%.

\*\*Fuel consumption depends on many factors, such as load, fuel quality, season, altitude, technical condition of the generator.

To ensure reliability and increase the engine service life, peak powers may be slightly limited by circuit breakers.

The optimal operating conditions are ambient temperature of 17-25°C, barometric pressure of 0.1 MPa (760 mm Hg), and relative humidity of 50-60%. Under these environmental conditions, the generator can provide maximum performance in terms of the declared specifications.

In the event of deviations from these environmental indicators, the generator performance may vary.

Please note that continuous loads exceeding 80% of the generator's rated power are not recommended in order to extend its service life.

## TERMS OF USE OF INVERTER GENERATOR

4

It is recommended to ground the generator before operating it for the first time. Before starting the device, remember that the total power of the connected power consumers should not exceed the nominal power of the generator.



**IMPORTANT!**



**Könnner & Söhnen generators were initially designed as an IT system with basic protection by insulation of hazardous live parts according to DIN VDE 0100-410.**

**The generator housing is insulated from the current-carrying L and N conductors. The generator must be grounded in all cases, except for an IT system with an insulated neutral wire and bonding. A grounded IT system requires the use of an insulation monitoring device.**



**IMPORTANT!**



**Make sure that the control panel, the blinds and the underside of the inverter are well cooled and protected against the ingress of small solids, dirt, and water. Improper operation of the cooler can cause damage to the motor, inverter or alternator.**

## GENERATOR OPERATION

5

### OIL LEVEL INDICATOR

When the oil level falls below the level required for operation, the oil level indicator lights up, and then the engine stops automatically. The engine will not start until oil is added.

### AC INDICATOR

When the generator is running and producing electricity, the AC indicator light is on.

### DC FUSE

The DC protector automatically switches to "OFF" when the current of the operating electrical device is higher than the rated current. To use this equipment again, turn on the DC fuse again by pressing the "ON" button.



**IMPORTANT!**



**If the DC fuse turns off, reduce the load of the connected electrical device. If the DC protector turns off again, stop operation and contact your nearest Könnner & Söhnen service center.**

### OVERLOAD INDICATOR

The overload indicator lights up when the connected generator is overloaded, the inverter control unit overheats or the AC output voltage rises.

If the overload indicator goes on, the engine will continue to operate, but the generator will no longer produce electricity. In this case, you must perform the following steps:

1. Turn off all connected electrical appliances and stop the engine.
2. Reduce the total power of the connected devices until the nominal power of the generator is reached.
3. Check if the vent grid is clogged. Remove excess dirt or debris, if any.
4. After checking, start the engine.



**IMPORTANT!**



**The overload indicator may light up within several seconds after start-up or when connecting electrical devices requiring a high starting current, such as a compressor or voltage indicator. However, this is not a malfunction.**

### FUEL TANK CAP AIR VENT (FOR MODEL KS 2000i S)

The fuel cap is equipped with a vent for air supply to the fuel tank. When the engine is running, the vent must be in the "ON" position (OPEN). This will allow fuel to enter the carburetor for engine operation. After the generator stops, allow it to cool down and close the air vent on the fuel cap. When the generator is not in use, close the vent to the "OFF" position.

### EARTHING BOLT

In all cases, except for an IT system with an insulated neutral wire and bonding, the generator earthing bolt must be connected to the grounding circuit with a flexible copper conductor with a cross-sectional area of at least 6 mm<sup>2</sup>.

**CHECKING THE FUEL LEVEL**

1. Unscrew the fuel cap and check the fuel level in the tank.
2. Fill the fuel tank to the fuel filter level.
3. Tighten the fuel cap securely.
4. For silent models of inverter generator, open the air intake vent on the fuel cap.

**Recommended fuel:** unleaded fuel.

**Fuel tank volume:** see specifications table.



**IMPORTANT!**



**Wipe up spilled fuel immediately with a clean, dry, soft cloth, as the fuel may harm painted surfaces or plastic parts.**



**IMPORTANT!**



**Use only unleaded gasoline. Using leaded gasoline can cause serious damage to the inside of the engine.**

**CHECKING THE OIL LEVEL**

The generator is transported free of motor oil. Do not start the engine until it is filled with sufficient amount of motor oil.

1. Unscrew the oil dipstick and wipe it out with a clean cloth.
2. Insert the dipstick without screwing it in.
3. Check the oil level by a mark on the oil dipstick.
4. Add oil if its level is below the mark on the oil dipstick.
5. Screw on the dipstick.

**Recommended motor oil:** SAE 10W30, SAE 10W40.

**Recommended motor oil grade:** API Service SG type or higher.

**Motor oil quantity:** see specifications table.

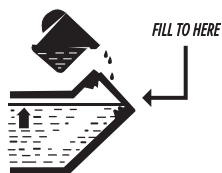

**Before starting the engine, make sure that the rated power of power consumers matches with the power of generator. Do not exceed the nominal power of the generator. Do not connect any devices before you start the engine!**



**IMPORTANT!**



**Do not change the controller settings in terms of the amount of fuel or speed governor (this adjustment was made at the factory). Otherwise, this may result in changes in the engine operation or its failure.**



**ATTENTION – DANGER!**



**In the power supply mode, the generator should operate no longer than 1 minute in the range from nominal to maximum power.**

**COMMISSIONING**

1. Fill the crankcase with engine oil. The recommended amount of oil for each model is indicated in the specification chart.
2. Check oil level with an oil dipstick. It should be between the MIN and MAX marks on the oil dipstick.
3. Check fuel level.
4. Check the air filter for correct installation



**IN THE FIRST 20 OPERATING HOURS OF THE GENERATOR, THE FOLLOWING REQUIREMENTS SHOULD BE MET:**

1. During commissioning, do not connect power consumers, the power of which exceeds 50% of the nominal (operating) power of the device.
2. After the first 20 operating hours, be sure to change the oil. It is better to drain oil while the engine is still hot after operation to ensure quick and complete oil draining.
3. Check and clean the air filter, fuel filter and spark plug.



**IMPORTANT!**



**Before starting the generator, connect the ground wire to the ground terminal.**

**ENGINE START**



**IMPORTANT!**



**Useful tip: If the engine stalls or does not start, turn the engine switch to the "ON" position, and then pull the manual starter. If the oil level indicator flickers for several seconds, add oil and restart the engine.**



**IMPORTANT!**



**Each time you start the generator, be sure to check oil and fuel level**

The generator is shipped with terminals disconnected to prevent battery self-discharge during storage. To connect the battery terminals of the KS 4000iE S generator, proceed as follows:



1. Open the service cover.

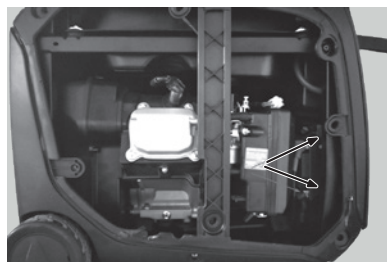

2. Connect the terminals ensuring the correct polarity ("+" to "+", "-" to "-").

**FOR MODELS KS 4100iE, KS 8100iE, KS 4000iE S, KS 8100iE ATSR**

1. Check oil level.
2. Check fuel level.
3. Turn the Multifunctional engine switch to the "START" position.
  - 4.1 For manual start (models KS 4100iE, KS 4000iE S), pull the manual starter until a slight resistance is felt, then pull it toward you relatively sharply. Slowly turn the manual starter by hand, do not release it abruptly.
  - 4.2 For electric start, press the red button on the multifunctional engine switch (fig. 1)
5. After starting the engine, turn the Multifunctional engine switch to the "RUN" position (fig. 1).

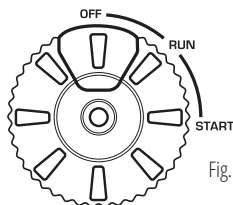

Fig. 1

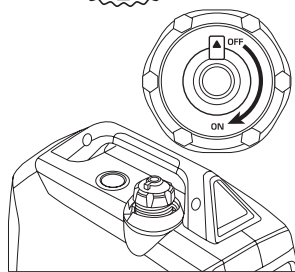

Fig. 2

**FOR MODEL KS 2000i S**

1. Check oil level.
2. Check fuel level.
3. Open the vent on the fuel cap to the "ON" position (fig. 2).
4. Turn the air choke control knob to the "START" position (fig. 3)

5. Pull the manual starter until a slight resistance is felt, then pull it toward you relatively sharply. Slowly turn the manual starter by hand, do not release it abruptly.

6. Turn the air choke control knob to the "RUN" position.

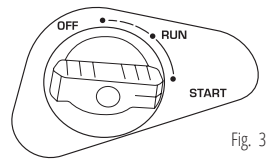

Fig. 3



**IMPORTANT!**



**Useful tip: to ensure long-term operation of the generator engine, it is important to observe the following tips:**

- Before connecting the load, allow the engine to run for 1-2 minutes to warm it up.
- When disconnecting the load after lengthy operation, do not turn off the generator. Allow the generator to run idle for 1-2 minutes so that it cools down.



**ATTENTION - DANGER!**



**Do not connect two or more devices at a time. The start-up of many devices requires high power. Devices should be connected one at a time according to their power rating. Do not connect any power consumers within the first 2 minutes after the generator has been started.**

### RUNNING GENERATOR ON LPG

(KS 4100iEG, KS 8100iEG ATSR, KS 8100iEG, KS 2000iG S, KS 4000iEG S)

1. Check oil level.
2. For LPG operation, set the gasoline switch to OFF.
3. Connect the LPG hose to the LPG input on the generator control panel (connect hose end **A** to the LPG input on the generator control panel, as shown in Fig. 4).
4. Connect the hose end with the reducer to the gas cylinder (connect hose end **B** to the gas cylinder, as shown in Fig. 4).
5. Open the gas valve on the cylinder, making sure that no gas is leaking.
6. Press the pressure relief valve on the reducer 2-3 times (see Fig. 4).
7. Close the air choke (pull the air choke handle) if the generator is not warmed up (except for models KS 8100iEG ATSR, KS 8100iEG, in which the air choke handle is not located on the control panel, but operates automatically).
8. When using for the first time, fill the gas line with gas by turning the key (pressing start button) to the "OFF" position and slowly pull the starter handle to the full cord length 2 to 3 times (except for models KS 8100, which do not have a manual start). For all modifications of models KS 8100 (or other models with electric start), perform a test start with a key by turning it to the "START" position for 1 second and repeating the operation after 15 seconds. The generator will start on the third try or earlier.
9. To start the generator manually, set the engine start button to the "ON" position, grasp the starter handle and slowly pull it until resistance is felt. Pull the starter cord to the full length with a sharp movement. The generator will start. If this is not the case, repeat this action. Slowly turn the manual starter by hand, do not release it abruptly.
10. Open the air choke by pushing the air choke handle (except for models KS 8100iEG, KS 8100iEG ATSR).

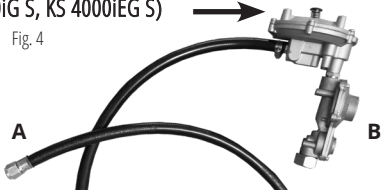

Fig. 4



**IMPORTANT!**



**Disconnect the load from the generator before changing fuel. The ECONOMY MODE switch must be in the "OFF" position. It is recommended to stop the generator before switching from gasoline to LPG!**

**Gasoline remains in the carburetor make it difficult to start the engine on LPG. Let the generator run out of gasoline until it stops. To do this, close the fuel valve with the generator running and wait until the generator stops completely. Then start the generator on LPG. You can also drain the remaining gasoline from the carburetor before starting the generator on LPG.**

To drain gasoline from the carburetor, turn off the fuel valve and wait until the generator has cooled down sufficiently. For open frame models, place a drip pan under the carburetor and loosen the drain screw on the carburetor (Fig. 5). Make sure that no fuel leaks onto the generator. Tighten up the screw again. Start the generator on LPG according to the instructions mentioned above

For all modifications of models KS 2000i, loosen the 2 screws on the side panel with a key (size 8). Loosen drain screw **C** on the carburetor and let the remaining fuel drain through pipe **D** into the dedicated drip pan. Avoid gasoline leaks. Tighten up the screw. Install back the generator housing cover. Start the generator on LPG.

For all modifications of models KS 4000i, loosen the 3 screws on the side panel with a key (size 8). Loosen drain screw **C** on the carburetor and let the remaining fuel drain through pipe **D** into the dedicated drip pan. Avoid gasoline leaks. Tighten up the screw. Install back the generator housing cover. Run the generator on LPG.

When switching from gasoline to LPG operation, the generator may be unstable during the first 2-3 minutes and the low voltage protection may trip. If the red indicator (overload indicator) lights up in 2-3 minutes after running the generator on LPG when it is running stable, press the AC Reset BUTTON on a panel of generator to restore voltage supply.

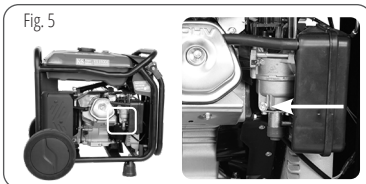

**TO START LPG/GASOLINE GENERATOR IN GASOLINE MODE (KS 4100iEG, KS 8100iEG ATSR, KS 2000iG S, KS 4000iEG S, KS 8100iEG)**

1. Close the gas valve on the cylinder.
2. Set the fuel switch to "ON".
3. Open the vent on the fuel cap to the "ON"
4. Close the air choke on the control panel (except for KS 8100iEG ATSR, KS 8100iEG).
5. Start the engine by hand or electric start.
6. Open the air choke (except for KS 8100iEG ATSR, KS 8100iEG).



**IMPORTANT!**



**Place the container with gas only vertically, according to the instruction manual for gas cylinders. The horizontal placement of gas cylinders leads to hybrid generator gearbox failure.**

For models with electric start, check if the battery is charged. If necessary, recharge the battery with a dedicated charger for lithium-ion batteries or start the generator with a manual start and allow it to run idle while it is recharging.

## FUNCTIONAL DESCRIPTION OF INVERTER GENERATORS

8

### ECON FUNCTION

1. Start the engine.
2. Set the ECON switch to "ON".
3. Plug the device into an AC outlet.
4. Make sure the AC indicator light is on.
5. Turn on the electrical device.



**IMPORTANT!**



**The ECON switch must be set to "OFF" to increase engine speed to nominal. When connecting multiple power consumers to the generator, be sure to first connect the one with the highest starting current, and the device with the lowest starting current should be connected last.**

## “ON” MODE

When the ECON switch is in the “ON” position, the control unit monitors the engine speed, reducing it commensurate with the connected load. If the engine speed is not enough to generate electricity to provide the load, the control unit will automatically increase the engine speed.

As a result, fuel consumption is optimized and noise levels are reduced.

## “OFF” MODE

The ECON switch must be set back to “OFF” when using electrical devices requiring a high starting current, such as a compressor or submersible pump.



**IMPORTANT!**



**The ECON switch must be set back to “OFF” when using electrical devices requiring a high starting current, such as a compressor or submersible pump.**

## PARALLEL FUNCTION

The total output power of the generators can be increased by connecting two inverter generators together using the Parallel Unit KS PU1 from Könnér & Söhnen. Parallel connection of two generators ensures total rated output power of these generators. When the generators are connected in parallel, the power loss is 0.2 kW of the total rated power that can be obtained (suitable for all models of inverter generators from Könnér & Söhnen, except for KS 8100iE, KS 8100iEG, KS 8100iE ATSR, KS 8100iEG ATSR).

## DISCONNECT ALL DEVICES BEFORE STOPPING THE GENERATOR!

Do not stop the generator with the devices turned on. This may disable the generator or devices connected to it!

## TO STOP THE ENGINE, PROCEED AS FOLLOWS:

### FOR MODELS KS 4100iE, KS 8100iE, KS 4000iE S, KS 8100iE ATSR

1. Turn off all devices.
2. Allow the generator to run idle for approx. 1-2 minutes.
3. Turn the Multifunctional engine switch to the “OFF” position (Fig. 7).
4. Unplug the devices.
5. After the generator stops, allow it to cool down.

### MODEL KS 2000i S AND LPG/GASOLINE GENERATORS

1. Turn off all devices.
2. Allow the generator to run idle for approx. 1-2 minutes.
3. Set the engine switch to the “OFF” position.
4. Turn the air choke control knob to the “OFF” position (Fig. 8), for dual fuel models - move the fuel switch to the OFF position/ close LPG supply valve.
5. Allow the generator to cool down.
6. Unplug the devices.
7. After the generator stops, allow it to cool down and close the air vent on the fuel cap (set to OFF, as shown in Fig. 6, for models KS 2000i S, KS 2000iG S - when switching off gasoline operation).

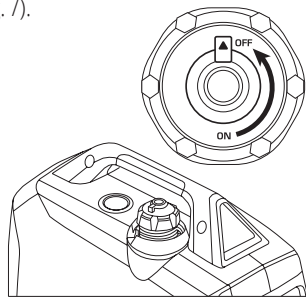

Fig. 6

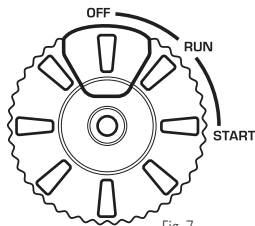

Fig. 7

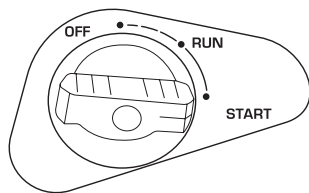

Fig. 8

## CHARGING AN EXTERNAL 12 V BATTERY

1. Start the engine.
2. Connect the red wire to the positive (+) terminal of the battery.
3. Connect the black wire to the negative (-) terminal of the battery.

4. Connect the wire to a 12V/8A DC socket on the control panel of the generator.
5. To start charging the battery, set ECON to "OFF".
6. Turn the 12 V DC fuse to the "ON" position.



**IMPORTANT!**



**Inverter generators from Könnner & Söhnen are equipped with lithium batteries with an operating voltage similar to conventional lead-acid batteries.**

**When the generator is running, the battery is charged automatically. If it is necessary to charge the battery with an external device, we recommend using the KS B1A charger or the charger for charging lead-acid motorcycle batteries with a nominal voltage of 12V with a charge current of not more than 2A.**



**IMPORTANT!**



- Make sure the ECON mode is off while the battery is being charged.
- Be sure to connect the charger's red wire to the plus (+) terminal of the battery and the black wire to the minus (-) terminal of the battery. Do not swap the terminals.
- Connect the charger to the battery terminals securely so that they are not disconnected due to motor vibrations or other actions.
- The 12 V socket can only be used as a backup source for recharging batteries and shall not be deemed as a full-featured battery charger.
- The DC protector turns off automatically if the current is higher than the rated current while the battery is being charged. To restore battery charging, turn on the DC fuse by pressing the "ON" button.



**ATTENTION – DANGER!**



**Never smoke or interrupt battery connections to the generator while the battery is being charged.**

## MAINTENANCE

9

This manual compliance! You can find a list of service center addresses on the website of exclusive importer: [www.ks-power.de/en](http://www.ks-power.de/en)

### TECHNICAL MAINTENANCE WORKS

Unit	Action	At each start	First month or 20 operating hours	Every 3 months or 50 operating hours	Every 6 months or 100 operating hours	Every year or 300 operating hours
<b>Motor oil</b>	Level check	✔				
	Replacement		✔	✔		
<b>Air filter</b>	Check /Cleaning	✔	✔	✔		
	Replacement				✔	
<b>Spark plug</b>	Cleaning		✔	✔		
	Replacement				✔	
<b>Fuel tank</b>	Level check	✔				
	Cleaning					✔
<b>Fuel filter</b>	Check (clean out)		✔	✔		

- If the generator often operates at high temperature or high load, the oil should be replaced every 25 operating hours.
- If the engine often runs in dusty or other harsh conditions, clean the air filter every 10 operating hours.
- If you missed the maintenance time, perform it as soon as possible to save the generator engine.



**IMPORTANT!**



**The manufacturer shall not be liable for any damage caused by failure to perform maintenance work.**

## RECOMMENDED OILS

10

Use oils designed for four-stroke cycle vehicle engines SAE10W-30, SAE10W-40. Motor oils with other viscosity levels, may be used only if the average air temperature in your region does not exceed the limits of the temperature range, specified in the table.

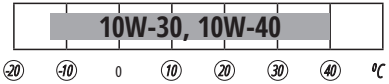

Upon oil level decrease it is necessary to add the required quantity in order to provide the correct generator operation. It is necessary to check the oil levels according to technical maintenance schedule. Further details can be found in the full version of the manual on our website.

## AIR FILTER TECHNICAL MAINTENANCE

11

Air filter cleaning is to be performed each 50 hours of the generator operation (every 10 hours in unusually dusty conditions).

### CLEANING THE FILTER:

1. Open the clips on the upper cap of the air filter.
2. Remove the sponge filtering element.
3. Remove all dirt deposits inside the hollow case of the air filter.
4. Thoroughly wash the filtering element in warmsoapy water.
5. Dry the sponge filter.
6. Dry filtering element is to be moistened by motor oil and excess oil is to be squeezed out.

## SPARK PLUGS TECHNICAL MAINTENANCE

12

Spark plug has to be intact, without soot deposits and to have a correct gap.

### SPARK PLUG VERIFICATION:

1. Remove the cap from the spark plug.
2. Remove the spark plug by means of a corresponding spanner.
3. Examine the spark plug. If it is shattered – it is necessary to replace it. Recommended replacement spark plugs – F7TC.
4. Measure the gap. It has to be within range 0.7-0.8 mm.
5. In case of repeated use, the spark plug has to be cleaned by means of a metal brush. After that – set the correct gap.

## DAMPER AND FLAME ARRESTER MAINTENANCE

13

The engine and damper will get very hot after the generator has been started. Do not touch the engine or damper with any part of your body or clothing during inspection or repair until they have cooled down.

Remove the screws and then pull the protective cover towards you. Loosen the bolts and remove the cover, screen and flame arrester of the damper. Descale the screen and flame arrester of the damper with a wire brush. Inspect the screen and flame arrester of the damper. Replace them if they are damaged. Replace the flame arrester. Replace the screen and cover of the damper. Replace the cover and tighten the screws.



**IMPORTANT!**



**Match the protrusion of the flame arrester to the hole in the pipe damper.**

## FUEL FILTER

14

**IMPORTANT!****Never use gasoline while smoking or in the immediate vicinity of an open flame.**

1. Remove the fuel tank cap and fuel filter.
2. Clean the filter with gasoline.
3. Wipe the filter and replace it.
4. Replace the fuel tank cap.

Make sure that the fuel tank cap is tight.

## BATTERY USE

15

The generator battery is not subject to service. Low temperatures may lower the capacity of the lithium-ion battery and may cause an unstable generator start. Battery warranted – three months from the date of purchase of the generator.

## STORAGE

16

**IMPORTANT!****The generator must be stored and transported with a closed vent at all times!**

Storage room has to be dry and free from dust deposits. Storage room also has to be locked away from children and animals. It is recommended to store and use the generator at temperature of -20°C to +40°C. Avoid direct sunlight, rain on the generator. When using and storing hybrid generator, gas tank should be kept indoors at temperatures below +10°C. If the temperature is lower, gas will evaporate. Information on long-term storage and transportation can be found in the full version of the manual.

*Potential faults and troubleshooting methods, as well as average device capacities can be found in the full version of the manual.*

## BATTERY AND GENERATOR DISPOSAL

17

To prevent environment damage generator and battery should be separated from ordinary waste. Please recycle them in the safest way, passing it to special place for disposal.

## WARRANTY SERVICE TERMS

18

The international manufacturer warranty is 1 year. The warranty period starts from the date of purchase. In cases when warranty period is longer than 1 year according to local legislation please contact your local dealer. The Seller which sells the product is responsible for granting the warranty. Please contact the Seller for warranty. Within the warranty period, if the product fails because of defects in the production process, it will be exchanged on the same product or repaired.

All faults caused by the manufacturer during the warranty period will be eliminated free of charge. Warranty repair is carried out only if you have a fully completed warranty card, the Buyer's signature of acceptance of the warranty terms, as well as a document supporting the purchase (cash receipt, sales slip or invoice). In the absence thereof, as well as in the event of errors or corrections not authenticated by the seller's seal or illegible inscriptions in the warranty card or tear-off coupon, no warranty repair is carried out, no objections to quality are accepted and the warranty card is withdrawn by the service center as invalid. The device is accepted for repair clean and full.



# EC Declaration of Conformity

Nr. 083

The following products have been tested by us with the listed standards and found in compliance with the European Community Machinery Directive 2006/42/EC, Electromagnetic compatibility Directive (EMC) 2014/30/EC, Noise Directive 2000/14/EC.

Manufacturer: DIMAX INTERNATIONAL GmbH  
Address: Hauptstr. 134, 51143 Cologne, Germany  
Product: Inverter generators "Könner & Söhnen"  
Type / Model: KS 2000i S, KS 2000iG S, KS 4000iE S, KS 4000iEG S, KS 4100iE, KS 4100iE G, KS 8100iE ATSR, KS 8100iEG ATSR, KS 8100iE, KS 8100iEG.

The statement is based on a single evaluation of above mentioned products. It does not imply an assessment of the whole production and does not permit the use of the test lab. logo. The manufacturer should ensure that all product in series production are in conformity with the product sample detailed in this report. The applicant should hold the whole technical report at disposal of the competent all the right.

Applied EC Directives: 2006/42/EC Machinery Directive  
2014/30/EC Electromagnetic compatibility Directive (EMC)  
2000/14/EC Noise Directive (amended in 2005/88/EC)  
(EU) 2016/1628 Non-Road mobile machinery emissions  
(EU)2017/654 amended by (EU) 2018/989  
(EU)2017/655 amended by (EU) 2018/987  
(EU)2017/656 amended by (EU) 2018/988

Applied Standards: EN ISO 8528-13:2016  
EN 55012:2007+A1  
EN 61000-6-1:2007  
00/14/EC  
55/88/EC

Gasoline engines KS 240i, KS 480i, KS 100i, correspond to European Emission Standard Euro V. This is confirmed by EU TYPE-APPROVAL CERTIFICATE issued by department of transport of Luxembourg. Technical service responsible for carrying out the test -TÜV Rheinland Luxembourg GmbH.  
Date of issue 30/10/2018

## 2000/14/EC\_2005/88/EC Annex VI

For model KS 4100iE, KS 4100iE G, KS 8100iE, KS 8100iEG, KS 8100iE ATSR, KS 8100iEG ATSR Noise measured  $L_{WA}$  = 95 dB (A),  
For model KS 2000i S, KS 2000iG S Noise measured  $L_{WA}$  = 87dB (A)  
For model KS 4000iE S, KS 4000iEG S Noise measured  $L_{WA}$  = 91dB (A)



Issued Date: 2020-10-15  
Place of issue: Cologne city  
General director: Fomin P. *P. Fomin*

DIMAX  
International  
GmbH  
Steuer-Nr: 103 5722 2493  
UStIdNr:DE296177274

We DIMAX INTERNATIONAL GmbH hereby declare that specified above conforms covering European Parliament and Council Directives, 2006/42/EC of 17 May 2006 Machinery Directive, Electromagnetic compatibility Directive (EMC) 2014/30/EC of 26 February 2014, Noise Directive 2000/14/EC of 8 May 2000. The CE mark above can be used under the responsibility of manufacturer. After completion of an EC declaration of Conformity and compliance with all relevant EC directives.



## CONTACTS

### **Deutschland:**

DIMAX International GmbH  
Deutschland, Hauptstr. 134,  
51143 Köln,

[www.ks-power.de](http://www.ks-power.de)

### **Ihre Bestellungen**

[orders@dimaxgroup.de](mailto:orders@dimaxgroup.de)

### **Kundendienst, technische Fragen und Unterstützung**

[support@dimaxgroup.de](mailto:support@dimaxgroup.de)

### **Garantie, Reparatur und Service**

[service@dimaxgroup.de](mailto:service@dimaxgroup.de)

### **Sonstiges**

[info@dimaxgroup.de](mailto:info@dimaxgroup.de)

---

### **Polska:**

DIMAX International  
Poland Sp.z o.o.

Polen, Warczawska,  
306B 05-082 Stare Babice,

[www.ks-power.pl](http://www.ks-power.pl)

[info.pl@dimaxgroup.de](mailto:info.pl@dimaxgroup.de)

---

### **Україна:**

ТОВ «Техно Трейд КС»,  
вул. Електротехнічна 47, 02222,  
м. Київ, Україна

[www.ks-power.com.ua](http://www.ks-power.com.ua)

[sales@ks-power.com.ua](mailto:sales@ks-power.com.ua)

---